

VARIS top

SKATE COMBINATION



VARIS TOP Proizvodnja in montaža d.o.o.

 00386 (2) 5776 500

 top@varis-lendava.si

Industrijska ulica 4b
SLO - 9220 LENDAVAL

 00386 (2) 5775 505

Name	Quantity
------	----------

Dimension (cm)

OLLY BOX	pcs
L=300 B=125 H=23/65	
MANUAL PAD MP 300	1
CURB CU 300	1
	2

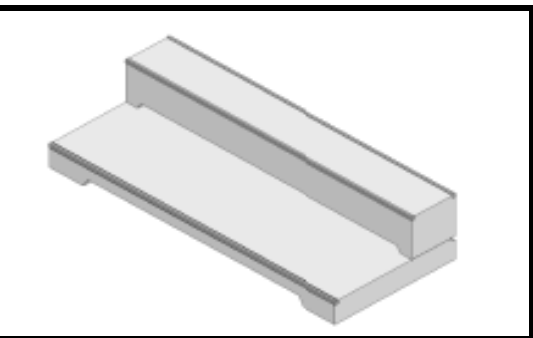

SPINE-RAMP	pcs
L=302 B=125 H=75	
COPING RAMP CR 75	2



L=338 B=125 H=98	
COPING RAMP CR 98	2



JUMP-BOX	pcs
L=425 B=125 H=60	
TABLE TA 60	1
BANK BA 60	1
JUMP RAMP JR 60	1

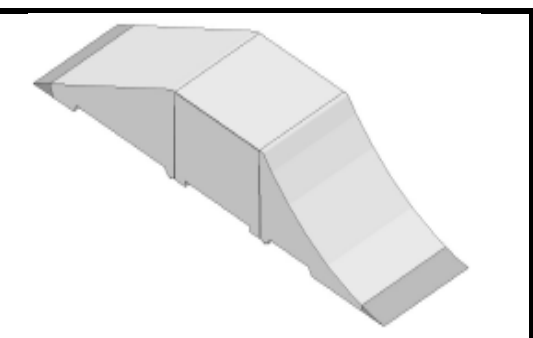

PYRAMID	pcs
L=570 B=442 H=60	
TABLE TA 60	2
BANK BA 60	6
PYRAMID HIP PH 60	4



L=570 B=442 H=75	
TABLE TA 75	2
BANK BA 75	6
PYRAMID HIP PH 75	4

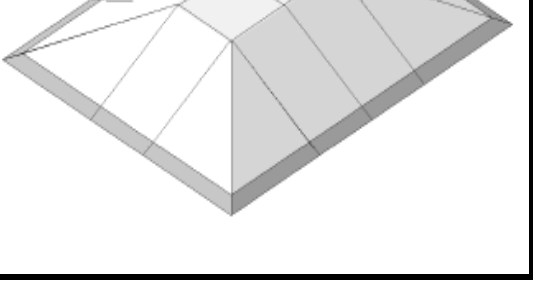

L=676 B=551 H=98	2
TABLE TA 98	6
BANK BA 98	4
PYRAMID HIP PH 98	

HALF PYRAMID MIT LEDGE	pcs
L=443 B=335 H=75/99	
TABLE TA 75	1
BANK BA 75	3
PYRAMID HIP PH 75	2
LEDGE LANG LL-98	1
LEDGE SHORT LK-98	1

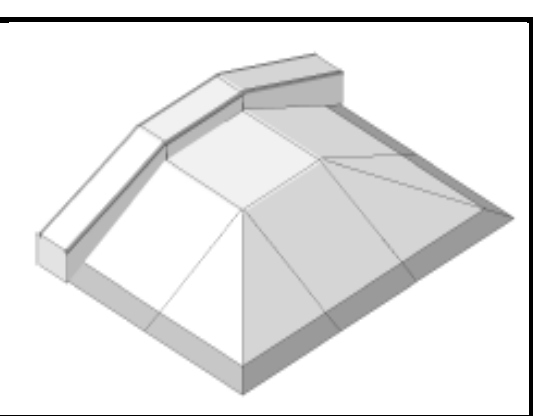

Name	Quantity
------	----------

Dimension (cm)

JUMPBOX MIT RAIL-SLIDE	pcs		
L=578 B=262 H=75/98/123			
TABLE TA 75	2		
JUMP RAMP JR 75	2		
TABLE TA 98	2		
BANK BA 98	2		
RAILSLIDE 123	2		

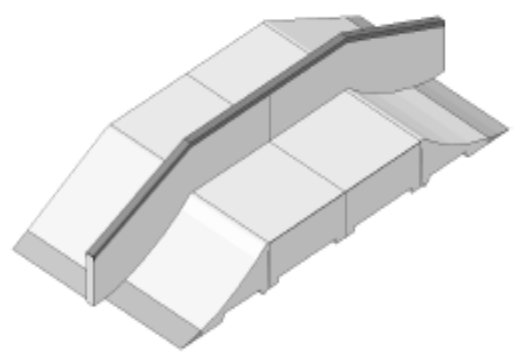

FUNBOX	pcs		
L=573 B=566 H=75/98			
TABLE TA 75	4		
JUMP RAMP JR 75	2		
BANK BA 75	2		
COPING RAMP CR 75	2		
COPING RAMP CR 98	2		

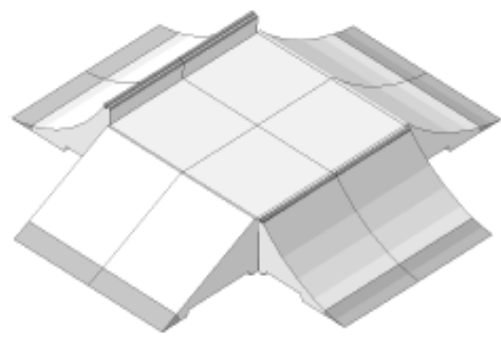

FUNBOX MIT LEDGE	pcs		
L=572 B=451 H=75/98			
TABLE TA 75	4		
STAIRS ST 60	1		
JUMP RAMP JR 75	2		
BANK BA 75	3		
PYRAMID HIP PH 75	1		
LEDGE LANG LL-98	2		
RAIL RTB 75	1		

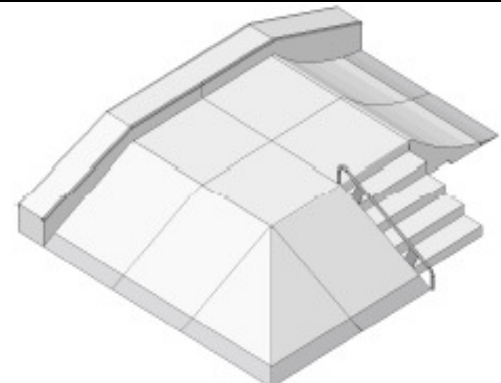

JUMPBOX MIT RAIL-SLIDE	pcs		
L=945 B=390 H=60/75/98/145			
TABLE TA 60	2		
BANK BA 60	1		
JUMP RAMP JR 60	1		
TABLE TA 75	3		
BANK BA 75	1		
COPING RAMP CR 75	2		
TABLE TA 98	1		
BANK BA 98	1		
WALLSLIDE WS 145	2		

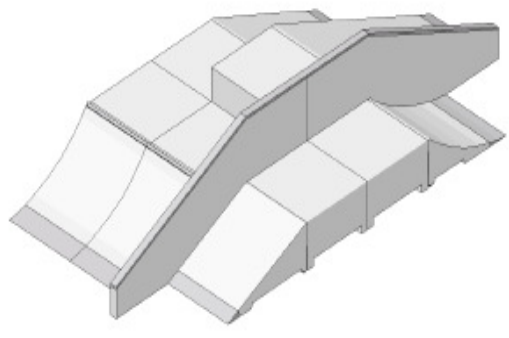

Name	Quantity
------	----------

Dimension (cm)

QUARTERRAMP	pcs		
<i>Self standing</i>			
L=946 B=375 H=150			
TABLE TA 150	3		
COPING RAMP CR 150	3		
RAIL SGEM 375	1		
RAIL SGEE 130 RIGHT	1		
RAIL SGEE 130 LEFT	1		
RAIL SGEE ANGULAR TILE	2		
QUARTERRAMP	pcs		
<i>Built into the ground</i>			
L=946 B=375 H=150			
TABLE TA 150	3		
COPING RAMP CR 150	3		

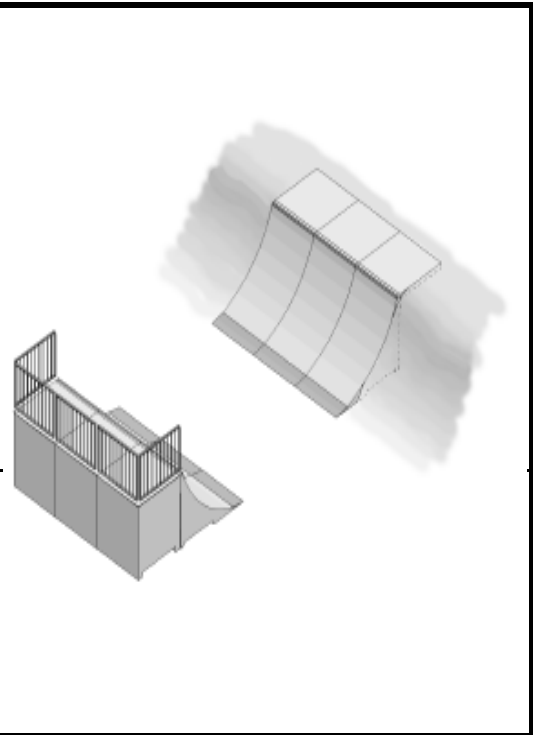

WALLRIDE	pcs		
L=275 B=240 H1=200/410			
WALLI WA 410	1		
WALL RAMP 200	1		

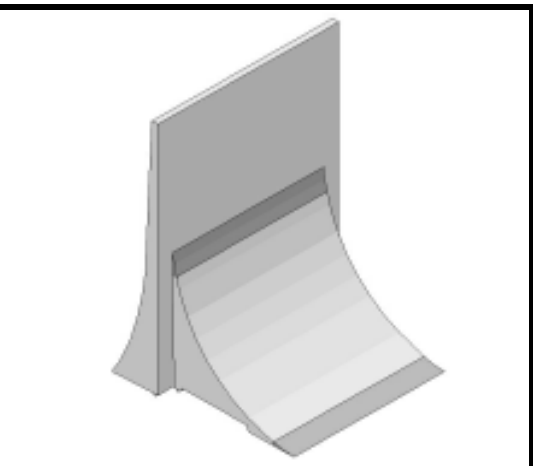

HALF POOL MIT PYRAMIDE, LEDGE & STAIRS	pcs		
L=1615 B=1252 H=98/123			
TABLE TA 98	10		
BANK BA 98	7		
PYRAMID HIP PH 98	2		
COPING RAMP CR 98	11		
RAILSLIDE RS 123	3		
LEDGE LANG LL 98	1		
CORNER CO 98	6		
CORNER TABLE CT 98	6		
KEGEL KE 98	2		
STAIRS ST 98	1		
	49		

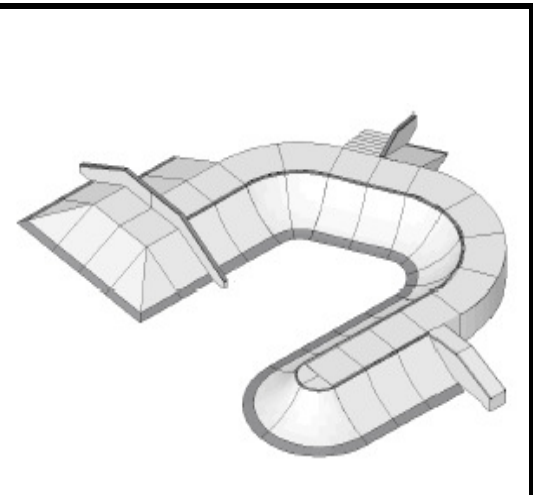

Name	Quantity
------	----------

Dimension (cm)

FUN BOWL	pcs		
L=1018 B=937 H=98			
JUMP RAMP JR 98	2		
TABLE TA 98	4		
CORNER CO 98	12		
CORNER TABLE CT 98	12		
COPING RAMP CR 98	4		
Built into the ground			

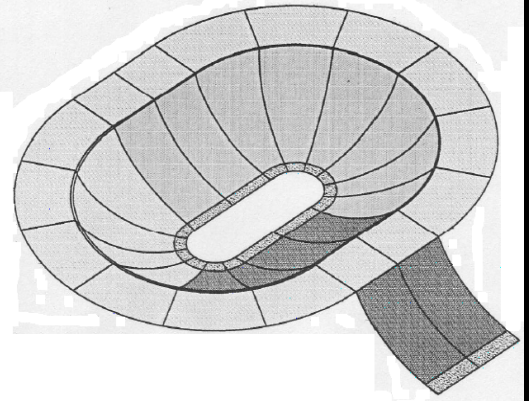

VARIS TOP d.o.o.